SPLIT SYSTEM**Air Conditioner**

MODELS
(Wall mounted type)

FAQ71CVEB**FAQ100CVEB**

English

Deutsch

Français

Español

Italiano

Ελληνικά

Nederlands

Português

Русский

Türkçe

Thank you for purchasing this Daikin air conditioner. Carefully read this operation manual before using the air conditioner. It will tell you how to use the unit properly and help you if any trouble occurs. After reading the manual, file it away for future reference. Furthermore, make certain that this operation manual is handed to a new user when he takes over the operation. This operation manual is dedicated for the indoor unit. Also refer to the operation manuals provided with the outdoor unit and remote controller.

Vielen Dank für den Kauf einer Klimaanlage von Daikin. Lesen Sie dieses Betriebshandbuch vor Inbetriebnahme der Klimaanlage sorgfältig durch. Sie erfahren hier, wie die Einheit korrekt genutzt wird, und es ist Ihnen bei Störungen behilflich. Wenn Sie das Handbuch durchgelesen haben, bewahren Sie es gut auf, damit Sie auch später noch nachschlagen können. Stellen Sie außerdem sicher, dass diese Betriebsanleitung an neue Benutzer ausgehändigt wird, wenn diese die Kontrolle über die Anlage übernehmen. Diese Betriebsanleitung hat das Innenaggregat zum Gegenstand. Bitte beachten Sie auch die mit dem Außenaggregat und der Fernbedienung gelieferten Betriebsanleitungen.

Nous vous remercions pour votre acquisition de ce système de climatisation Daikin. Lisez attentivement ce manuel avant d'utiliser le climatiseur. Il vous expliquera comment vous servir correctement de l'appareil et vous guidera en cas de problème. Lorsque vous aurez lu le manuel, rangez-le afin de pouvoir vous y référer ultérieurement. Veuillez également à ce que le présent manuel d'utilisation soit remis au nouvel utilisateur avant qu'il commence à travailler. Le présent manuel d'utilisation porte sur l'unité intérieure. Reportez-vous également aux manuels d'utilisation fournis avec l'unité extérieure et la télécommande.

Le agradecemos la compra de este acondicionador de aire Daikin. Lea cuidadosamente el manual de funcionamiento antes de utilizar el acondicionador de aire. Dicho manual le indicará cómo utilizar adecuadamente la máquina y le ayudará en caso de avería. Después de leer el manual, consérvelo para consultas futuras. Además, asegúrese de que cuando un nuevo usuario asume el funcionamiento se le proporciona este manual de instrucciones. Este manual de instrucciones está dirigido a la unidad interior. Consulte también los manuales de instrucciones proporcionados con la unidad exterior y el mando a distancia.

La ringraziamo di aver acquistato questo condizionatore d'aria Daikin. Leggere attentamente questo manuale prima di utilizzare il condizionatore. Contiene le istruzioni per usare correttamente l'unità e per rimediare ad eventuali problemi di funzionamento. Dopo averlo letto, conservare il manuale per consultazioni future. Inoltre, non dimenticare di consegnare questo manuale d'uso al nuovo utente che dovesse subentrare. Il presente manuale d'uso è riservato all'unità interna. Consultare anche i manuali d'uso forniti insieme all'unità esterna ed al comando a distanza.

Σας ευχαριστούμε που αγοράσατε αυτή την κλιματιστική συσκευή της Daikin. Διαβάστε προσεκτικά αυτό το εγχειρίδιο χρήσης πριν χρησιμοποιήσετε την κλιματιστική συσκευή. Θα σας εξηγήσει πώς να χρησιμοποιείτε τη μονάδα σωστά και θα σας βοηθήσει αν παρουσιαστεί κάποιο πρόβλημα. Αυτό το εγχειρίδιο περιγράφει μόνο την εσωτερική μονάδα. Χρησιμοποιήστε το μαζί με το εγχειρίδιο λειτουργίας για την εξωτερική μονάδα. Αφού διαβάσετε το εγχειρίδιο, φυλάξτε το για μελλοντική χρήση. Λειτουργία: δείτε τις οδηγίες λειτουργίας του τηλεχειριστηρίου για λεπτομέρειες σχετικά με τα ονόματα και τις λειτουργίες των διακοπών και των θορών του τηλεχειριστηρίου. Επιπλέον, μην παραλείψετε να παραδώσετε αυτό το εγχειρίδιο λειτουργίας σε έναν νέο χρήστη, όταν αυτός θα αναλάβει τη λειτουργία της μονάδας. Αυτό το εγχειρίδιο προορίζεται αποκλειστικά για την εσωτερική μονάδα. Επίσης, συμβουλευτείτε τα εγχειρίδια λειτουργίας που παρέχονται με την εξωτερική μονάδα και το τηλεχειριστήριο.

Wij danken u voor de aankoop van deze Daikin airconditioner. Lees deze bedrijfshandleiding aandachtig door voordat u de airconditioner gebruikt. Het omvat uitleg over het correcte gebruik van de unit en biedt hulp in geval een storing mocht optreden. Gebruik deze handleiding voor verdere raadpleging. Zorg er tevens voor dat deze gebruiksaanwijzing aan elke nieuwe gebruiker overhandigd wordt. Deze gebruiksaanwijzing behandelt specifiek de binneneenheid. Raadpleeg tevens de gebruiksaanwijzingen van de buitenunit en de afstandsbediening.

Obrigado por ter adquirido este aparelho de ar condicionado Daikin. Leia atentamente este manual de operação antes de utilizar o ar condicionado. Este indicará-lhe-á como utilizar correctamente a unidade e fornecer-lhe-á ajuda caso ocorra algum problema. Após a leitura, guarde este manual num local onde qualquer utilizador o possa ler a qualquer altura. Além disso, certifique-se de que este manual de operação é entregue a cada novo utilizador que assumir o controlo da operação. Este manual de operação destina-se à unidade interior. Consulte também os manuais de operação fornecidos com a unidade exterior e o controlo remoto.

Благодарим за покупку кондиционера Daikin. До начала работы с кондиционером внимательно изучите данное руководство по эксплуатации. В нем излагаются правила пользования и приводятся рекомендации по поиску и устранению неисправностей. После изучения руководства сохраните его для справки. Более того, следует убедиться, что новый пользователь, приступая к работе, получил настоящее руководство. Настоящее руководство предназначено для внутреннего блока. Смотрите также руководство для наружного блока и пульта дистанционного управления.

Daikin klima satın aldığınız için teşekkür ederiz. Klimanızı kullanmadan önce bu kullanma kılavuzunu dikkatlice okuyunuz. Bu kılavuz ünitenin nasıl uygun olarak kullanılacağını anlatır ve herhangi bir problem olduğunda size yardım eder. Kullanma kılavuzunu okuduktan sonra ileride tekrar faydalanmak üzere saklayınız. Ayrıca, bu kullanım kılavuzunun çalışmayı devralan yeni kullanıcılar da verildiğinden emin olun. Bu kullanım kılavuzu, iç ünite için hazırlanmıştır. Ayrıca, dış ünite ve uzaktan kumandayla birlikte verilen kullanım kılavuzlarına da bakın.

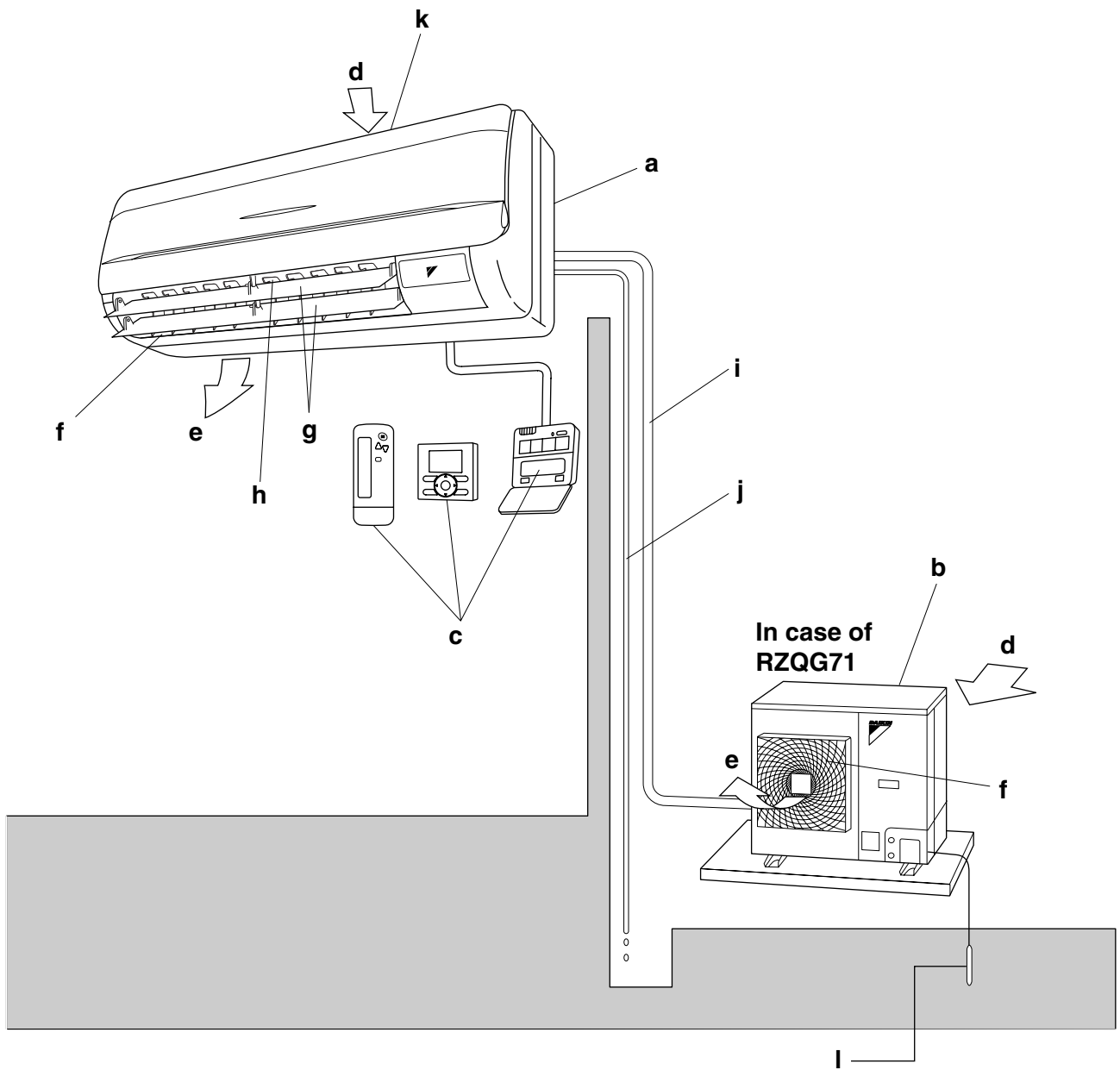

■ DISPOSAL REQUIREMENTS ■ VORSCHRIFTEN ZUR ENTSORGUNG ■ INSTRUCTIONS D'ÉLIMINATION
■ REQUISITOS PARA LA ELIMINACIÓN ■ SPECIFICHE DI SMALTIMENTO ■ ΠΡΟΫΠΟΘΕΣΕΙΣ ΑΠΟΡΡΙΨΗΣ
■ VEREISTEN VOOR HET OPRUIJEN ■ REQUISITOS PARA A ELIMINAÇÃO ■ ТРЕБОВАНИЯ К УТИЛИЗАЦИИ
■ BERTARAF GEREKSINIMLERI

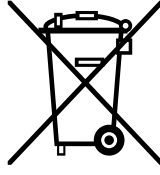

GB Disposal requirements

Your air conditioning product is marked with this symbol. This means that electrical and electronic products shall not be mixed with unsorted household waste.

Do not try to dismantle the system yourself: the dismantling of the air conditioning system, treatment of the refrigerant, of oil and of other parts must be done by a qualified installer in accordance with relevant local and national legislation.

Air conditioners must be treated at a specialized treatment facility for re-use, recycling and recovery. By ensuring this product is disposed of correctly, you will help to prevent potential negative consequences for the environment and human health. Please contact the installer or local authority for more information.

Batteries must be removed from the remote controller and disposed of separately in accordance with relevant local and national legislation.

D Vorschriften zur Entsorgung

Ihre Klimaanlage ist mit diesem Symbol gekennzeichnet. Das bedeutet, dass elektrische und elektronische Produkte nicht mit unsortiertem Haushaltsabfall entsorgt werden dürfen.

Versuchen Sie auf keinen Fall das System selbst zu demontieren. Die Demontage des Klimaanlage-Systems sowie die Handhabung von Kältemitteln, Öl und möglichen weiteren Teilen muss von einem qualifizierten Monteur gemäß den entsprechenden örtlichen und staatlichen Bestimmungen vorgenommen werden.

Klimaanlagen müssen bei einer fachkundigen Einrichtung für Wiederverwendung, Recycling und Wiedergewinnung aufbereitet werden. Indem Sie dieses Produkt korrekt entsorgen, helfen Sie potenzielle negative Folgen für die Umwelt und die Gesundheit der Menschen zu vermeiden. Nehmen Sie bitte hinsichtlich weiterer Informationen Kontakt auf mit dem Monteur oder den örtlichen Behörden.

Die Batterien müssen aus der Fernbedienung entfernt werden und gemäß den entsprechenden örtlichen und staatlichen Vorschriften separat entsorgt werden.

F Instructions d'élimination

Cet appareil de conditionnement d'air porte le symbole ci-joint. Ce symbole signifie que les appareils électriques et électroniques doivent être éliminés séparément des ordures ménagères non triées.

N'essayez pas de démonter vous-même l'appareil : le démontage de l'appareil de conditionnement d'air ainsi que le traitement du réfrigérant, de l'huile et d'autres composants doivent être effectués par un installateur qualifié, en accord avec les réglementations locales et nationales en vigueur.

Les appareils de conditionnement d'air doivent être traités dans des installations spécialisées de dépannage, réutilisation ou recyclage. En vous assurant que cet appareil est éliminé correctement, vous contribuez à éviter les conséquences potentiellement néfastes sur l'environnement et la santé. Veuillez contacter votre installateur ou les autorités locales pour plus d'information.

Les piles de la télécommande doivent être enlevées et éliminées séparément, conformément aux réglementations locales et nationales en vigueur.

E Requisitos para la eliminación

Su acondicionador de aire está marcado con este símbolo. Esto significa que los productos eléctricos y electrónicos no deben mezclarse con el resto de residuos domésticos no clasificados.

No intente desmontar el sistema usted mismo: El desmantelamiento del acondicionador de aire, así como el tratamiento del refrigerante, aceite y otros componentes, debe ser efectuado por un instalador competente de acuerdo con las normas locales y nacionales aplicables.

Los acondicionadores de aire deben ser tratados en instalaciones especializadas para su reutilización, reciclaje y recuperación. Al asegurarse de desechar este producto de la forma correcta, está contribuyendo a evitar posibles consecuencias negativas para el entorno y para la salud de las personas. Contacte, por favor, con el instalador o con las autoridades locales para obtener más información.

Las pilas del control remoto deben extraerse y eliminarse por separado y de acuerdo con la normativa local y nacional aplicable.

I Specifiche di smaltimento

Il climatizzatore è contrassegnato con questo simbolo, ciò significa che i prodotti elettrici ed elettronici non possono essere smaltiti insieme ai rifiuti domestici non differenziati.

Non cercare di demolire il sistema da soli: la demolizione del sistema di condizionamento, nonché il recupero del refrigerante, dell'olio e di qualsiasi altra parte devono essere eseguiti da un installatore qualificato in conformità alla legislazione locale e nazionale vigente in materia.

I climatizzatori devono essere trattati presso una struttura specializzata nel riutilizzo, riciclaggio e recupero dei materiali. Il corretto smaltimento del prodotto eviterà le possibili conseguenze negative all'ambiente e alla salute dell'uomo. Per maggiori informazioni contattare l'installatore o le autorità locali.

Le batterie devono essere tolte dal telecomando e smaltite separatamente conformemente alla legislazione locale e nazionale vigente in materia.

GR Προϋποθέσεις απόρριψης

Το κλιματιστικό σας επισημαίνεται με αυτό το σύμβολο. Αυτό σημαίνει ότι οι ηλεκτρικές και ηλεκτρονικές συσκευές πρέπει να απορρίπτονται χωριστά από τα οικιακά απορρίμματα.

Μην προσπαθήσετε να αποσυναρμολογήσετε μόνοι σας το σύστημα: Η αποσυναρμολόγηση της μονάδας κλιματισμού, ο χειρισμός του ψυκτικού μέσου, του λαδιού και των άλλων μερών θα πρέπει να γίνεται από κάποιο ειδικευμένο τεχνικό, σύμφωνα με τη σχετική τοπική και εθνική νομοθεσία.

Για την εκ νέου χρήση, την ανακύκλωση και την επισκευή, οι μονάδες κλιματισμού θα πρέπει να υφίστανται επεξεργασία σε ειδικές εγκαταστάσεις. Επιβεβαιώνοντας ότι αυτό το προϊόν απορρίπτεται σωστά, θα αποφύγετε ενδεχόμενες αρνητικές συνέπειες για το περιβάλλον και την υγεία. Παρακαλώ επικοινωνήστε με τον τεχνικό εγκατάστασης ή τις τοπικές αρχές για περισσότερες πληροφορίες.

Οι μπαταρίες θα πρέπει να αφαιρούνται από το τηλεχειριστήριο και να απορρίπτονται ξεχωριστά, σύμφωνα με τη σχετική τοπική και εθνική νομοθεσία.

NL Vereisten voor het opruijen

Uw airconditioningproduct draagt dit symbool. Dit betekent dat u geen elektrische en elektronische producten mag mengen met niet-gesorteerd huishoudelijk afval.

Probeer niet zelf het systeem te ontmantelen: het ontmantelen van het airconditioningsysteem, behandelen van het koelmiddel, olie en andere onderdelen moet worden uitgevoerd door een bevoegd installateur in overeenstemming met de relevante lokale en nationale reglementeringen.

Airconditioners moeten bij een gespecialiseerd behandelingsbedrijf worden behandeld voor hergebruik, recyclage en terugwinning. Door ervoor te zorgen dat dit product op de correcte manier wordt opgeruimd, helpt u potentiële negatieve gevolgen voor het milieu en de gezondheid te voorkomen. Voor meer informatie, gelieve contact op te nemen met de installateur of de lokale overheid.

De batterijen moeten uit de afstandsbediening worden verwijderd en afzonderlijk opgeruimd in overeenstemming met de relevante lokale en nationale reglementeringen.

P Requisitos para a eliminação

O equipamento de ar condicionado que possui este símbolo significa que os produtos eléctricos e electrónicos não devem ser misturados com o lixo doméstico indiferenciado.

Não tente desmontar pessoalmente o sistema: o desmantelamento do sistema de ar condicionado e o tratamento do líquido de refrigeração, do óleo e de outros componentes têm de ser feitos por um instalador qualificado, cumprindo a legislação nacional relevante e regulamentos locais aplicáveis.

Os equipamentos de ar condicionado têm de ser processados numa estação de tratamento especializada, para reutilização, reciclagem ou recuperação. Ao certificar-se de que este produto é eliminado correctamente, está a contribuir para evitar as potenciais consequências negativas para o ambiente e para a saúde humana. Contacte o seu instalador ou as autoridades locais, para obter mais informações.

As pilhas do controlo remoto têm de ser retiradas e eliminadas separadamente, cumprindo a legislação nacional e os regulamentos locais aplicáveis.

RUS Требования к утилизации

Ваш кондиционер помечен этим символом. Это значит, что электрические и электронные изделия не следует смешивать с несортированным бытовым мусором.

Не пытайтесь демонтировать систему самостоятельно: демонтаж системы, удаление холодильного агента, масла и других частей должны проводиться квалифицированным монтажником в соответствии с местным и общегосударственным законодательством. Кондиционеры необходимо сдавать на специальную перерабатывающую станцию для утилизации, переработки и вторичного использования. Обеспечивая надлежащую утилизацию настоящего изделия, вы способствуете предотвращению наступления возможных негативных последствий для окружающей среды и здоровья людей.

За более подробной информацией обращайтесь к монтажнику или в местные органы власти.

Аккумуляторные батареи необходимо извлечь из пульта дистанционного управления и утилизировать отдельно в соответствии с действующим местным и общегосударственным законодательством.

TR Bertaraf gereksinimleri

Klimanız bu sembole işaretlenmiştir. Bu da elektrikli ve elektronik ürünlerin, ayrılmaması evsel atıklarla karıştırılmaması gerektiği anlamına gelir. Sistem kendi kendinize sökmeye çalışmayın: klima sisteminin sökülmesi ve soğutucu akışkan, yağ ve diğer parçalarla ilgili işlemler yerel ve ulusal mevzuata uygun olarak bir montaj görevlisi tarafından gerçekleştirilmelidir. Klimalar yeniden kullanın, geri dönüştürme ve kazanım için özel bir işleme tesisine gönderilmelidir. Bu ürünün doğru şekilde bertaraf edilmesini sağlayarak, çevre ve insan sağlığı için olası olumsuz sonuçların önlenmesine yardımcı olursunuz. Lütfen, daha fazla bilgi için montaj görevlisi veya ilgili kurum ile iletişime geçin. Uzaktan kumandadaki piller çıkartılmalı ve ilgili yerel ve ulusal mevzuat uyarınca ayrı olarak bertaraf edilmelidir.

CONTENTS

ILLUSTRATION	[1]
1. SAFETY PRECAUTIONS	1
2. WHAT TO DO BEFORE OPERATION	3
3. OPERATION RANGE	5
4. INSTALLATION SITE	5
5. OPERATION PROCEDURE	5
6. OPERATION CHARACTERISTICS	6
7. OPTIMUM OPERATION	8
8. MAINTENANCE (FOR SERVICE PERSONNEL)	8
9. NOT A MALFUNCTION OF THE AIR CONDITIONER	11
10. TROUBLE SHOOTING	13

The original instructions are written in English. All other languages are translations of the original instructions.

Important information regarding the refrigerant used

This product contains fluorinated greenhouse gases covered by the Kyoto Protocol.

Refrigerant type: R410A

GWP⁽¹⁾ value: 1975

⁽¹⁾ GWP = global warming potential

Periodical inspections for refrigerant leaks may be required depending on European or local legislation. Please contact your local dealer for more information.

1. SAFETY PRECAUTIONS

To gain full advantage of the air conditioner's functions and to avoid malfunction due to mishandling, please read this operation manual carefully before use.

This product comes under the term "appliances not accessible to the general public".

This appliance is intended to be used by expert or trained users in shops, in light industry and on farms, or for commercial use by lay persons.

This appliance can be used by children aged from 8 years and above and persons with reduced physical, sensory or mental capabilities or lack of experience and knowledge if they have been given supervision or instruction concerning use of the appliance in a safe way and

understand the hazards involved. Children shall not play with the appliance. Cleaning and user maintenance shall only be done by persons described in manual.

The appliance is not intended for use by unattended young children or persons who are incompetent to operate air conditioners.

It may result in injury or electric shocks.

- **This manual classifies the precautions into WARNINGS and CAUTIONS. Be sure to follow all the precautions below: They are all important for ensuring safety.**

⚠ WARNING Indicates a potentially hazardous situation which, if not avoided, could result in death or serious injury.

⚠ CAUTION Indicates a potentially hazardous situation which, if not avoided, may result in minor or moderate injury. It may also be used to alert against unsafe practices.

- **After reading, keep this manual in a convenient place so that you can refer to it whenever necessary. If the equipment is transferred to a new user, be sure also to hand over the manual.**

⚠ WARNING
When the air conditioner is malfunctioning (giving off a burning odor, etc.), turn off the power to the air conditioner and contact your local dealer.

Continued operation under such circumstances may result in a failure, electric shocks or a fire.

Consult your local dealer regarding modification, repair and maintenance of the air conditioner.

Improper workmanship may result in water leakage, electric shocks or a fire.

Be sure to use fuses with the correct ampere reading. Do not use improper fuses, copper or other wiring as a substitute, as this may result in electric shocks, a fire, injury or damage to the air conditioner.

Consult your local dealer if the air conditioner submerges owing to a natural disaster, such as a flood or typhoon.

Do not operate the air conditioner in that case, or otherwise a malfunction, electric shocks, or a fire may result.

Start or stop the air conditioner with the remote controller. Never use the power circuit breaker for this purpose.

Otherwise, it may cause a fire or water leakage. Furthermore, if an automatic restart control is provided against power failure and the power is recovered, the fan will rotate suddenly and may cause injury.

Do not use the air conditioner in the atmosphere contaminated with oil vapor, such as cooking oil or machine oil vapor.

Oil vapor may cause crack damage to the air conditioner, electric shocks, or a fire.

Do not use flammable materials (e.g., hairspray or insecticide) near the air conditioner.

Do not clean the air conditioner with organic solvents such as paint thinner.

The use of organic solvents may cause crack damage to the air conditioner, electric shocks, or a fire.

Do not use the air conditioner in places with excessive oily smoke, such as cooking rooms, or in places with flammable gas, corrosive gas, or metal dust.

Using the air conditioner in such places may cause a fire or air conditioner failures.

Beware of a fire in case of refrigerant leakage.

If the air conditioner is not operating correctly, i.e. not generating cool or warm air, refrigerant leakage could be the cause. Consult your local dealer for assistance. The refrigerant used for the air conditioner is safe and normally does not leak. However, if the refrigerant leaks and gets in contact with a naked burner, heater or cooker, it may generate hazardous compounds. Turn off the air conditioner and call your local dealer. Turn on the air conditioner after the qualified service person makes sure to confirm that the leakage is repaired.

Do not place objects, including rods, your fingers, etc., in the air inlet or outlet.

Injury may result due to contact with the air conditioner's highspeed fan blades.

Consult your local dealer regarding cleaning the inside of the air conditioner.

Improper cleaning may cause breakage of plastic parts, water leakage and other damage as well as electric shocks.

Be aware that prolonged, direct exposure to cool or warm air from the air conditioner, or to air that is too cool or too warm can be harmful to your physical condition and health.

Consult your local dealer about installation work.

Doing the work yourself may result in water leakage, electric shocks or a fire.

Contact professional personnel about attachment of accessories and be sure to use only accessories specified by the manufacturer.

If a defect results from your own workmanship, it may result in water leakage, electric shocks or a fire.

Consult your local dealer regarding relocation and reinstallation of the air conditioner.

Improper installation work may result in leakage, electric shocks or a fire.

Be sure to earth the air conditioner.

Do not earth the air conditioner to a utility piping, lightning conductor or telephone earth lead.

Imperfect earthing may result in electric shocks or a fire. A high surge current from lightning or other sources may cause damage to the air conditioner.

Be sure to install an earth leakage breaker.

Failure to install an earth leakage breaker may result in electric shocks or a fire.

Be sure to use a dedicated power supply for the air conditioner.

The use of any other power supply may cause heat generation, a fire, or air conditioner failures.

Consult your local dealer regarding what to do in case of refrigerant leakage.

When the air conditioner is installed in a small room, it is necessary to take proper measures so that the amount of any leaked refrigerant does not exceed the concentration limit in the event of a leakage. Otherwise, this may lead to an accident due to oxygen depletion.

 **CAUTION**

Children should be watched so that they do not play with the indoor unit or its remote controller.

Accidental operation by a child may result in injury or electric shocks.

Do not allow a child to mount on the outdoor unit or avoid placing any object on it.

Falling or tumbling may result in injury.

Do not let children play on or around the outdoor unit.

If they touch the unit carelessly, injury may be caused.

Be sure that children, plants or animals are not exposed directly to airflow from the indoor unit, as adverse effects may ensue.

Do not place flammable sprays or operate spray containers near the air conditioner as this may result in a fire.

Do not wash the air conditioner or the remote controller with water, as this may result in electric shocks or fire.

Do not place water containers (flower vases, etc.) on the indoor unit, as this may result in electric shocks or a fire.

Do not put flammable containers, such as spray cans, within 1 m from the air outlet.

The containers may explode because the warm air from the indoor or outdoor unit will affect them.

Turn off the power when the air conditioner is not used for long periods of time.

Otherwise, the air conditioner may get hot or catch on a fire due to dust accumulation.

Do not place objects in direct proximity of the outdoor unit and do not let leaves and other debris accumulate around the unit.

Leaves are a hotbed for small animals which can enter the unit. Once in the unit, such animals can cause malfunctions, smoke or a fire when making contact with electrical parts.

Before cleaning, be sure to stop the air conditioner operation, turn the power circuit breaker off.

Otherwise, an electric shocks and injury may result.

To avoid electric shocks, do not operate with wet hands.

Never touch the internal parts of the remote controller.

Touching certain internal parts will cause electric shocks and damage to the remote controller. Consult your local dealer about checking and adjustment of internal parts.

To avoid oxygen deficiency, ensure that the room is adequately ventilated if equipment such as a burner is used together with the air conditioner.

Do not leave the remote controller wherever there is a risk of wetting.

If water gets into the remote controller there is a risk of electrical leakage and damage to electronic components.

Watch your steps at the time of air filter cleaning or inspection.

High-place work is required, to which utmost attention must be paid.

If the scaffold is unstable, you may fall or topple down, thus causing injury.

Do not remove the outdoor unit's outlet side grille.

The grille protects against the unit's high speed fan, which may cause injury.

To avoid injury, do not touch the air inlet or aluminum fins of the air conditioner.

Do not place objects that are susceptible to moisture directly beneath the indoor or outdoor units.

Under certain conditions, condensation on the unit or refrigerant piping, air filter dirt or drain blockage may cause dripping, resulting in fouling or failure of the object concerned.

Do not place heaters directly below the indoor unit, as resulting heat can cause deformation.

Do not place appliances that produce naked flames in places exposed to the airflow from the air conditioner as this may impair combustion of the burner.

Do not block air inlets nor outlets.

Impaired airflow may result in insufficient performance or trouble.

Do not use the air conditioner for purposes other than those for which it is intended.

Do not use the air conditioner for cooling precision instruments, food, plants, animals or works of art as this may adversely affect the performance, quality and/or longevity of the object concerned.

Do not install the air conditioner at any place where there is a danger of flammable gas leakage.

In the event of a gas leakage, build-up of gas near the air conditioner may result in a fire.

Carry out drain piping properly to ensure complete drainage.

If drain piping is not carried out properly, drain will not flow out. Then, dirt and debris may be accumulated in the drain piping and may cause water leakage. If it occurs, stop the air conditioner and call your local dealer for assistance.

NOTE TO SERVICE PERSONNEL

WARNING

May cause electric shock, ignition, fire

- Before starting the inspection of the electrical parts (control box, fan motor, drain pump, etc.), be sure cut off the all air-conditioner power of indoor unit and outdoor unit and other power, or you may get an electric shock.
- When cleaning the heat exchanger, be sure to remove the switch box, fan motor and drain pump. Water or detergent may deteriorate the insulation of electric components and result in burn-out of these components.
- Due to high voltage, do not open control box lid for ten minutes after the safety breaker is switched off.

CAUTION! ELECTRIC SHOCK

- Due to high voltage, do not open control box lid for ten minutes after the safety breaker is switched off.
- After the box is opened, measure the voltages of the points shown below printed circuit board with a tester and confirm that the voltages are not higher than DC50V.
Do not touch live parts when carrying out this work.

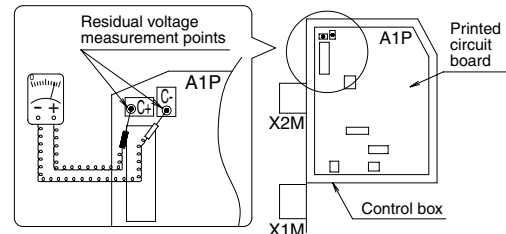

- After power failure, operation will restart automatically.

2. WHAT TO DO BEFORE OPERATION

This operation manual is for the following systems with standard control. Before initiating operation, contact your Daikin dealer for the operation that corresponds to your system.

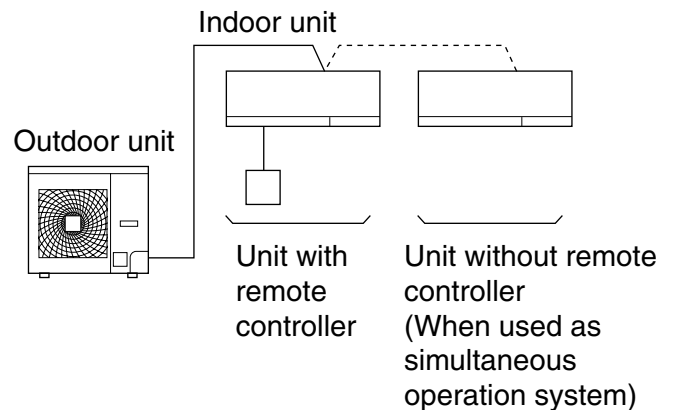

NOTE

- Read the operation manual that came with the remote controller you are using.

If your installation has a customized control system, ask your Daikin dealer for the operation that corresponds to your system.

- Heat pump type
This system provides COOLING, HEATING, AUTOMATIC, PROGRAM DRY, and FAN OPERATION modes.
- Cooling only type
This system provides COOLING, PROGRAM DRY, and FAN OPERATION modes.

PRECAUTIONS FOR GROUP CONTROL SYSTEM OR TWO REMOTE CONTROLLER CONTROL SYSTEM

This system provides two other control systems beside individual control (one remote controller controls one indoor unit) system. Confirm the following if your unit is of the following control system type.

- **Group control system**

One remote controller controls up to 16 indoor units.

All indoor units are equally set.

- **Two remote controllers control system**

Two remote controllers control one indoor unit (In case of group control system, one group of indoor units)

NOTE

- Contact your Daikin dealer in case of changing the combination or setting of group control and two remote controller control systems.
- Please do not change the combination and settings for the group operation and two remote controller control systems by yourself, but be sure to ask your dealer.

Names and functions of parts

Refer to figure on page [1]

a	Indoor unit
b	Outdoor unit
c	Remote controller There are two types of wired remote controller. One is BRC1D type, another is BRC1E type. When using the BRC1D type, please refer to this operation manual. When using the BRC1E type and wireless remote controller, please refer to operation manual provided with the remote controller. The remote controller may not be needed depending on the system configuration.
d	Inlet air
e	Discharged air
f	Air outlet
g	Airflow flap (Vertical airflow direction adjustment flap)
h	Airflow flap (Horizontal airflow direction adjustment flap)
i	Refrigerant piping, electric wire connection, earth wire
j	Drain pipe
k	Air inlet The built-in air filter removes dust and dirt.
l	Earth wire Wire to ground from the outdoor unit to prevent electrical shocks and fire.

3. OPERATION RANGE

If the temperature or the humidity is beyond the following conditions, safety devices may work and the air conditioner may not operate, or sometimes, water may drop from the indoor unit.

COOLING [°C]

OUTDOOR UNIT	INDOOR		OUTDOOR TEMPERATURE
	TEMPERATURE	HUMIDITY	
RZQG	DB	18 to 37	80% or below
	WB	12 to 28	
RZQSG71-100-140	DB	21 to 37	80% or below
	WB	14 to 28	
RZQ200	DB	21 to 37	80% or below
	WB	14 to 28	

HEATING [°C]

OUTDOOR UNIT	INDOOR TEMPERATURE		OUTDOOR TEMPERATURE	
RZQG	DB	10 to 27	DB	-19.5 to 21
			WB	-20 to 15.5
RZQSG71	DB	10 to 30	DB	-14 to 21
			WB	-15 to 15.5
RZQSG100-140	DB	10 to 28	DB	-14 to 21
			WB	-15 to 15.5
RZQ200	DB	10 to 27	DB	-14 to 21
			WB	-15 to 15

DB: Dry bulb temperature
WB: Wet bulb temperature

The setting temperature range of the remote controller is 16°C to 32°C.

4. INSTALLATION SITE

Regarding places for installation

- **Is the air conditioner installed at a well-ventilated place where there are no obstacles around?**
- **Do not use the air conditioner in the following places.**
 - a. Filled with much mineral oil such as cutting oil
 - b. Where there is much salt such as a beach area
 - c. Where sulfured gas exists such as a hot-spring resort
 - d. Where there are considerable voltage fluctuations such as a factory or plant
 - e. Vehicles and vessels
 - f. Where there is much spray of oil and vapor such as a cookery, etc.

- g. Where there are machines generating electromagnetic waves
 - h. Filled with acid and/or alkaline steam or vapor
- **Is a snow protection measure taken?**
For details, consult your dealer about snow protection hoods, etc.

Regarding wiring

- **All wiring must be performed by an authorized electrician.**
To do wiring, ask your dealer. Never do it by yourself.
- **Make sure that a separate power supply circuit is provided for this air conditioner and that all electrical work is carried out by qualified personnel according to local laws and regulations.**

Pay attention to running noises, too

- **Are the following places selected?**
 - a. A place that can sufficiently withstand the weight of the air conditioner with less running noises and vibrations.
 - b. A place where the hot wind discharged from the air outlet of the outdoor unit and the running noises do not cause a nuisance to neighbours.
- **Are you sure that there are no obstacles near the air outlet of the outdoor unit?**
Such obstacles may result in declined performance and increased running noises.
- **If abnormal noises occur in use, stop the operation of the air conditioner, consult your dealer.**

Regarding drainage of drain piping

- **Is the drain piping carried out properly to ensure complete drainage?**
If drain piping is not carried out properly, dirt and debris may be accumulated in the drain pipe and cause water leakage. If it occurs, stop the air conditioner and consult with your dealer for assistance.

5. OPERATION PROCEDURE

Read the operation manual that came with the remote controller.

- Operating procedure varies with heat pump type and cooling only type. Contact your Daikin dealer to confirm your system type.
- To protect the unit, turn on the main power switch 6 hours before operation.
- If the main power supply is turned off during operation, operation will restart automatically after the power turns back on again.

6. OPERATION CHARACTERISTICS

[CHARACTERISTICS OF THE COOLING OPERATION (COOLING OPERATION AND AUTOMATIC COOLING OPERATION)]

- After continued operation at a downward airflow direction, operate the air conditioner using a different direction setting for a period of time to prevent condensation on the airflow flaps. (The remote controller displays the airflow direction that is set.)
- If the COOLING OPERATION is used when the indoor temperature is low, frost forms on the heat exchanger of the indoor unit. This can decrease the cooling capacity. In this case, the system automatically switches to DEFROST OPERATION for a while.
During DEFROST OPERATION, the low airflow rate is used to prevent the discharge of melt water. (The remote controller displays the airflow rate that is set.)
- When the outdoor temperature is high, it takes some time until the indoor temperature reaches the set temperature.

[CHARACTERISTICS OF THE HEATING OPERATION (HEATING OPERATION AND AUTOMATIC HEATING OPERATION)]

START OF OPERATION

- It generally takes a longer time for HEATING OPERATION to reach the set temperature compared to COOLING OPERATION. It is advisable to start operation in advance using TIMER OPERATION.

Perform the following operation to prevent heating capacity decrease and discharge of cool air.

AT THE START OF OPERATION AND AFTER DEFROST OPERATION

- A warm air circulating system is employed, and therefore it takes some time until the entire room is warmed up after the start of operation.
- The indoor fan runs to discharge a gentle wind automatically until the temperature inside the air conditioner reaches a certain level. At this time, the remote controller displays “/””. Leave it as it stands and wait for a while.
(The remote controller displays the airflow rate that is set.)
- The air discharge direction becomes horizontal to prevent a draft of cool air to the inhabitants. (The remote controller will display the set air discharge direction.)

DEFROST OPERATION (Frost removal operation for the outdoor unit)

- As the frost on the coil of an outdoor unit increase, heating effect decreases and the system goes into DEFROST OPERATION.
- The indoor unit fan stops and the remote controller display shows “”.
With the wireless remote controller, the warm air stops, and the DEFROST OPERATION lamp for the light receiving unit indicator lights. (The remote controller displays the airflow rate that is set.)
- After 6 to 8 minutes (maximum 10 minutes) of DEFROST OPERATION, the system returns to HEATING OPERATION.
- The air discharge direction becomes horizontal. (The remote controller displays the airflow direction that is set.)
- When the operation is switched to the HEATING OPERATION during or after the DEFROST OPERATION, white mist comes out from the air outlet of the outdoor unit.
(Refer to “VII.” on page 12.)
- A hissing and “Shuh” sound may be heard during this particular operation.

Regarding outside air temperature and heating capacity

- The heating capacity of the air conditioner declines as the outside air temperature falls. In such a case, use the air conditioner in combination with other heating systems.
(When a combustion appliance is used, ventilate the room regularly.)
Do not use the combustion appliance where the air from the air conditioner is blown directly toward it.
- When the warm air stays under the ceiling and your feet are cold, we recommend that you use a circulator (a fan to circulate the air inside the room). For details, consult your dealer.
- When the indoor temperature exceeds the set temperature, the air conditioner discharges a gentle breeze (switches to whisper mode). The air discharge direction becomes horizontal. (The remote controller displays the airflow rate and airflow direction that are being set.)

[CHARACTERISTICS OF THE PROGRAM DRY OPERATION]

- This operation lowers the humidity without lowering the indoor temperature. The indoor temperature when the operation button is pressed will be the set temperature. At this time, the airflow rate and temperature are set automatically, so the remote controller does not display the airflow rate and set temperature.
To efficiently lower the indoor temperature and humidity, first lower the indoor temperature using the COOLING OPERATION, and then use PROGRAM DRY OPERATION. When the indoor temperature is lowered, air discharge from the air conditioner may stop.
- After continued operation at a downward airflow direction, operate the air conditioner using a different direction setting for a period of time to prevent condensation on the airflow flaps. (The remote controller displays the airflow direction that is set.)
- If the PROGRAM DRY OPERATION is used when the indoor temperature is low, frost forms the heat exchanger of the indoor unit. In this case, the system automatically switches to DEFROST OPERATION for a while.

[SOUND PRESSURE LEVEL]

- Sound pressure level is less than 70 dB(A).



AIRFLOW DIRECTION ADJUST

- There are 2 ways of adjusting the airflow direction. (When the operation stops, the airflow flaps at the air outlet (vertical airflow direction adjustment flaps) close automatically.)

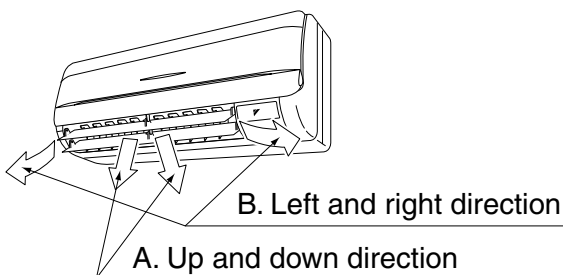

A. UP AND DOWN DIRECTION

Press the **AIRFLOW DIRECTION ADJUST** button to select the air direction as following.

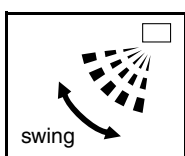

The AIRFLOW DIRECTION display swings as shown the left and the airflow direction continuously varies. (Automatic swing setting)



Press AIRFLOW DIRECTION ADJUST button to select the air direction of your choice.

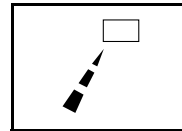

The AIRFLOW DIRECTION display stops swinging and the airflow direction is fixed (Fixed airflow direction setting).

MOVEMENT OF THE AIRFLOW FLAP

For the following conditions, micro computer controls the airflow direction so it may be different from the display.

Operation mode	<ul style="list-style-type: none"> • COOLING • AUTOMATIC COOLING • PROGRAM DRY 	<ul style="list-style-type: none"> • HEATING • AUTOMATIC HEATING
Vertical airflow	<ul style="list-style-type: none"> • When operating continuously at downward airflow direction (Air blows in the automatically set direction for a period of time to prevent condensation on the airflow flaps.) 	<ul style="list-style-type: none"> • When room temperature is higher than the set temperature • When the HEATING OPERATION starts or during DEFROST OPERATION (if frost forms on the outdoor unit) (The air discharge direction becomes horizontal so that it does not blow directly toward your body.)

Recommended flap positions

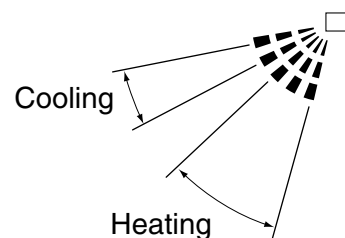

We recommend using the airflow in the position listed above when fixing the airflow direction.

B. LEFT AND RIGHT DIRECTION

Hold the tabs on edge louvers (horizontal airflow direction adjustment flaps) down slightly and adjust left and right to match the room conditions or your preference.

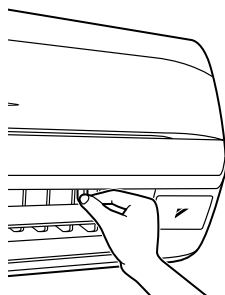

Stop the horizontal flaps at a position where you can hold the tabs and adjust it left and right.

NOTE

- Only make adjustments after you have stopped the airflow direction swing in a position where adjustments are possible. Your hand may get caught if you attempt to make adjustments while the unit is swinging.

7. OPTIMUM OPERATION

Observe the following precautions to ensure the system operates.

- Prevent direct sunlight from entering a room during COOLING OPERATION by using curtains or blinds.
- Keep doors and windows closed. If the doors and windows remain open, room air will flow out and decrease the effect of cooling and heating.
- Never place objects near the air inlet and the air outlet of the unit. It may deteriorate the effect or stop the operation.
- Adjust the room temperature properly for a comfortable environment. Avoid excessive heating or cooling.
Not doing so wastes electricity.
- When the display shows “” or “Time to clean filter”, ask a qualified service person to clean the filters.
(Refer to “MAINTENANCE” on page 8.)
Operating the unit with stained air filter may decrease capacity or cause malfunction.
- Install TVs, radios, and stereos 1 m or more away from the indoor unit and remote controller.
Images may become fuzzy and noise may be generated.

- Turn off the power circuit breaker when it is not in use for a long period. When the power circuit breaker is turned on, small amount of power is consumed even if the system is not in operation. (*1) Turn off the power circuit breaker for saving energy. When reoperating, turn on the power circuit breaker 6 hours before operation for smooth running.

(Refer to “MAINTENANCE” on page 8.) (*2)

*1 The consumed power while the outdoor unit is not in operation depends on the model.

*2 The setting before the power circuit breaker is cut off is stored. (The timer setting is cleared.)

- Fully use the function of airflow direction adjust. Cold air gathers on the floor, and warm air gathers in the ceiling.
Set the air discharge to horizontal direction during COOLING or PROGRAM DRY OPERATION, and set it downwards during HEATING OPERATION. Do not let the air blow directly to a person.
- Use the TIMER OPERATION effectively.
It takes some time until the indoor temperature reaches the set temperature. It is advisable to start operation in advance using TIMER OPERATION.

8. MAINTENANCE (FOR SERVICE PERSONNEL)

ONLY A QUALIFIED SERVICE PERSON IS ALLOWED TO PERFORM MAINTENANCE

WARNING

- Do not use flammable gas (such as hair sprays and insecticides) near the air conditioner.
Do not wipe the indoor unit with benzine or thinner.
This may cause cracking, electric shock, or fire.

CAUTION

- Do not wash the air conditioner with water
Doing so may result in an electric shock and fire.
- To clean the air conditioner, be sure to stop operation, and turn the power circuit breaker off. It may cause electric shock or injury.
- Be careful of your footing when working at high places.
Unstable footing may cause the person to fall and get injured.

NOTE 

- Do not remove the air filter except for during cleaning. Doing so may damage the unit.
- Do not install anything (such as kitchen paper) other than the approved air filters on the air inlet. Doing so may lower operation efficiency and cause freezing or leakage.

HOW TO CLEAN THE AIR FILTER

When the remote controller indicates “” or “Time to clean filter”, clean the air filter.

- It indicates after running for a certain time.

NOTE 

- The time until the display appears can be changed. For information on using the air conditioner in a dirty place, contact your dealer.

Stain	Time until display appears
Standard	200 hours (approx. 1 month)
When the amount of staining is large	100 hours (approx. 2 weeks)

1. Open the front panel.

Place your fingers on the panel protrusions on the left and right sides of the main unit and open until the panel stops.

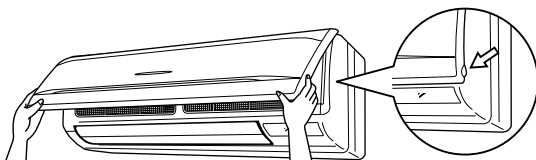

2. Pull out the air filter

Push up the tab in the center of the air filter slightly, then pull out the filter downward.

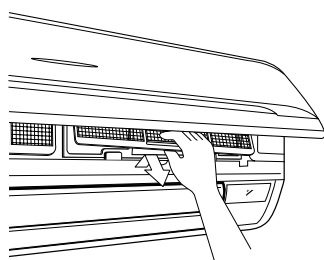

NOTE 

- After removing the filter, do not touch the heat exchanger to avoid cutting your hand.

3. Clean the air filter.

Use vacuum cleaner **A)** or wash the air filter with water **B)**.

A) Using a vacuum cleaner



B) Washing with water

When the air filter is very dirty, use soft brush and neutral detergent.



Remove water and dry in the shade.

NOTE 

- Do not wash the air filter with water which is 50°C or more, as doing so may result in discoloration and/or deformation.
- Do not expose it to fire, as doing so may result in burning.

4. Attach the air filter.

Once cleaning is done be sure to replace the air filter as it was.

5. Close the front panel.

6. Turn off the indication “” or “Time to clean filter” displayed on the remote controller after turning on the power.

- For details, refer to the operation manual attached to the remote controller.

The indication can be turned off whether in operation or at stop.

HOW TO CLEAN AIR INLET, AIR OUTLET, EXTERIOR, AND REMOTE CONTROLLER

- Wipe with a soft dry cloth.
- If a stain cannot be removed, wipe it with a cloth firmly wringed after soaked in diluted neutral detergent. After that, wipe the area with a dry cloth.

NOTE 

- Do not use gasoline, benzene, thinner, polishing powder, or commercially supplied liquid insecticide. This may cause discoloration or deformation.
- Do not use water which is 50°C or more. This may cause discoloration or deformation.

HOW TO CLEAN THE FRONT PANEL

You can remove the front panel to clean it.

⚠ CAUTION

- Hold the front panel firmly so that it does not fall.
- Do not use water which is 50°C or more, benzene, gasoline, thinner, or other volatile substances, polishing powder, or hard scrub brushes to clean the panel.
- Do not expose it to fire, as doing so may result in burning.
- Make sure the front panel is solidly in place.

1. Open the front panel.

Place your fingers on the panel protrusions on the left and right sides of the main unit and open until the panel stops.

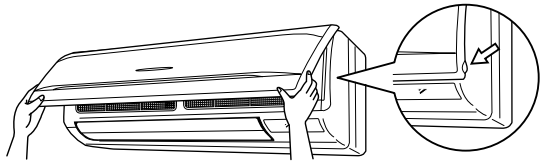

2. Remove the front panel.

Push the axis on either side of the front panel towards the center of the main unit and remove it.

(You can also remove it by sliding the front panel either to the left or right and pulling it forward.)

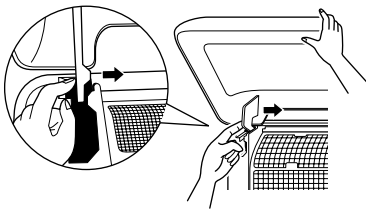

3. Clean the front panel.

- Wipe gently with a soft wet cloth.
- Only use neutral cleaning agents.
- After washing, wipe off the remaining water completely and dry in the shade.

4. Attach the front panel.

Set the keys of the front panel into the slots and push them in all the way.

Close the front panel slowly in this state.

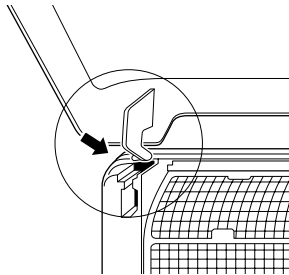

5. Close the front panel.

[CLEANING BEFORE AND AFTER SEASONAL USE]

START UP AFTER A LONG STOP

Confirm the following

- Check that the air inlet and outlet are not blocked. Remove any obstacle. Obstacles may decrease the airflow rate, leading to performance decline and breakage of the devices.

Clean the air filter

- After cleaning the air filter, make sure to attach it. (Refer to "MAINTENANCE" on page 8.)
- Turn off the indication " " or "Time to clean filter" displayed on the remote controller after turning on the power.
- For details, refer to the operation manual attached to the remote controller. The indication can be turned off whether in operation or at stop.

Turn on the power circuit breaker at least 6 hours before operation.

- To protect the unit, this is required in order to activate the unit smoothly.
- The display on the remote controller will be shown when the power circuit breaker is turned on.

HEATING OPERATION within 6 hours after the power is supplied to the power circuit breaker.

- Some models perform the following operation to protect the devices. If the HEATING OPERATION is performed within 6 hours after the power is supplied to the power circuit breaker, the indoor fan stops for about 10 minutes during the outdoor unit operation to protect the devices.

The above operation is performed not only at the time of installation, but every time the power circuit breaker is turned on/off.

For comfort heating, it is recommended not to turn off the power circuit breaker during HEATING OPERATION.

WHAT TO DO TO STOP THE SYSTEM FOR A LONG PERIOD

- This will prevent generation of mould.

Turn off the power circuit breaker.

- When the power circuit breaker is turned on, low wattage is consumed even if the system is not operating. Turn off the power circuit breaker for saving energy.
- The display on the remote controller will vanish when the power circuit breaker is turned off.

Clean the air filter.

- Be sure to replace the air filter to its original place after cleaning. (Refer to "MAINTENANCE" on page 8.)

9. NOT A MALFUNCTION OF THE AIR CONDITIONER

The following symptoms do not indicate air conditioner malfunction

- **HEATING OPERATION within 6 hours after the power is supplied to the power circuit breaker.** Some models perform the following operation to protect the devices.

If the HEATING OPERATION is performed within 6 hours after the power is supplied to the power circuit breaker, the indoor fan stops for about 10 minutes during the outdoor unit operation to protect the devices.

The above operation is performed not only at the time of installation, but every time the power circuit breaker is turned on/off.

For comfort heating, it is recommended not to turn off the power circuit breaker during HEATING OPERATION.

I. THE SYSTEM DOES NOT OPERATE

- **The system does not restart immediately after the ON/OFF button is pressed.**
- **The system does not restart immediately when TEMPERATURE SETTING button is returned to the former position after pushing the button.**

If the OPERATION lamp lights, the system is in normal condition.

It does not restart immediately because a safety device operates to prevent overload of the system. After approx. 3 minutes, the system will turn on again automatically.

- **The system does not start when the display shows “” and it flashes for few seconds after pressing an operation button.**

This is because the system is under centralized control. Flashes on the display indicates that the system cannot be controlled by the remote controller.

- **HEATING OPERATION within 6 hours after the power is supplied to the air conditioner.** Some models perform the following operation to protect the devices.

If the HEATING OPERATION is performed within 6 hours after the power is supplied to the air conditioner, the indoor fan stops for about 10 minutes during the outdoor unit operation to protect the devices.

The above operation is performed not only at the time of installation, but every time the power circuit breaker is turned off/on.

For comfortable use, do not turn off the power circuit breaker during seasonal use of the HEATING OPERATION.

- **The outdoor unit stops.**

This is because the indoor temperature has reached the set temperature. The indoor unit is in the FAN OPERATION.

COOLING OPERATION (AUTOMATIC COOLING OPERATION): Lower the set temperature.
HEATING OPERATION (AUTOMATIC HEATING OPERATION): Raise the set temperature.

The operation starts after a while when the system is in normal condition.

- **The remote controller displays “”, and air discharge stops.**

This is because the system automatically switches to DEFROST OPERATION to prevent a decrease in heating capacity when frost on the outdoor unit increases.

After 6 to 8 minutes (maximum 10 minutes), the system returns to its original operation.

II. THE OPERATION SOMETIMES STOPS.

- **The remote controller displays “U4” and “U5”, and the operation stops. However, it will restart in a few minutes.**

This is because communication between the units is shut off and stops the operation due to noise caused by devices other than the air conditioner.

When the electrical noise decreases, the system automatically restarts.

III. THE FAN SPEED IS DIFFERENT FROM THE SETTING.

- **Even if the fan speed control button is pressed, the fan speed does not change.**

For the DEFROST OPERATION during the COOLING OPERATION, the airflow rate is lowered to prevent the carryover of melted water. After a while, the airflow rate can be changed. (The airflow rate cannot be set for the PROGRAM DRY OPERATION.)

When the room temperature exceeds the set temperature the indoor unit goes into whisper mode. It takes some time until the airflow rate changes.

Raise the set temperature. After a while, the airflow rate changes.

IV. AIR BLOW DIRECTION IS NOT AS SPECIFIED.

- **Actual air blow direction is not as shown on the remote controller.**
- **Automatic swing setting does not work.**

This is because the airflow rate is automatically controlled.

After a while, the airflow direction can be changed.

V. THE AIRFLOW DIRECTION DIFFERS FROM THE REMOTE CONTROLLER DISPLAY.

- **The airflow flaps do not swing when the remote controller displays the swing operation.**

<HEATING OPERATION>

This is because the airflow direction is controlled so it is horizontal right after the operation starts or when the indoor temperature is higher than the set temperature to prevent air from blowing directly toward your body.

After a while, the swing operation starts.

(Refer to "MOVEMENT OF THE AIRFLOW FLAP" on page 7.)

- **The airflow direction display of the remote controller differs from the actual operation of the airflow flaps.**

<COOLING and PROGRAM DRY OPERATIONS>

When the operation in a downward airflow direction is set, the airflow direction differs from the display for a period of time to prevent the flaps from getting frosted.

After a while, the airflow direction changes to the set direction.

(Refer to "MOVEMENT OF THE AIRFLOW FLAP" on page 7.)

<HEATING OPERATION>

This is because the airflow direction is controlled so it is horizontal right after the operation starts or when the indoor temperature is higher than the set temperature to prevent air from blowing directly toward your body.

After a while, the airflow direction changes to the set direction.

(Refer to "MOVEMENT OF THE AIRFLOW FLAP" on page 7.)

VI. AIRFLOW FLAPS DO NOT CLOSE.

- **The airflow flaps do not close even when operation stops.**

If the air discharge is set downward, to avoid condensation on the flaps, the flaps once close and then open again.

After a while they close again.

VII. WHITE MIST COMES OUT OF A UNIT

- **When humidity is high during COOLING OPERATION (In oily or dusty places)**

If the inside of an indoor unit is extremely contaminated, the temperature distribution inside a room becomes uneven. It is necessary to clean the inside of the indoor unit. Ask your Daikin dealer for details on cleaning the unit. This operation requires a qualified service person. Check the usage environment.

- **When the operation is switched to the HEATING OPERATION during or after the DEFROST OPERATION.**

Moisture generated by defrost becomes steam and will float around.

When the remote controller display shows

"", the unit is in DEFROST OPERATION.

VIII. NOISE OF AIR CONDITIONERS

- **A ringing sound after the unit starts.**

This sound is generated when the motors for driving the airflow flaps are working. It will quiet down after about a minute.

- **A continuous flow "Shuh" sound is heard when the systems is in COOLING or DEFROST OPERATION.**

This is the sound of refrigerant gas flowing through both indoor and outdoor units.

- **A "Shuh" sound which is heard at the start or immediately after the stop of operation or which is heard at the start or immediately after the stop of DEFROST OPERATION.**

This is the noise of refrigerant caused by flow stop and flow change.

During HEATING OPERATION, the system switches to DEFROST OPERATION automatically. The remote controller shows ".

After 6 to 8 minutes (maximum 10 minutes), the system returns to its original operation.

- **A continuous flow "Shah" sound is heard when the system is in COOLING OPERATION or at a stop.**

Moisture removed from the indoor air during the COOLING OPERATION is drained. (The draining device is provided as an optional part.)

- **A "Pishi-pishi" squeaking sound is heard when the system is in operation or after the stop of operation.**

Expansion and contraction of plastic parts caused by temperature change makes this noise.

IX. DUST FROM THE UNITS

- **Dust may blow out from the unit after starting operation from long resting time.**

Dust absorbed by the unit blows out.

X. THE UNITS GIVE OFF ODORS

- **During operation**

The unit absorbs the smell of rooms, furniture, cigarettes, etc., and then emits them.

If odor is a concern, you can set to zero airflow rate when the indoor temperature reaches the set temperature.

For details, contact your Daikin dealer.

XI. THE UNIT DOES NOT COOL EFFECTIVELY.

- **The unit is operating in program dry mode.**

This is because program dry mode operates so that the indoor temperature decreases as little as possible.

Lower the indoor temperature using COOLING OPERATION, and then use PROGRAM DRY OPERATION.

(Refer to "CHARACTERISTICS OF THE PROGRAM DRY OPERATION" on page 7.)

- Read through characteristics of the COOLING OPERATION, characteristics of the HEATING OPERATION, and characteristics of the PROGRAM DRY OPERATION on page 6, 7.

10. TROUBLE SHOOTING

Please check before requesting a service call.

1. If the system does not operate at all.

- Check if fuse has blown.
Turn off the power supply.
- Check if the power circuit breaker is blown.
Turn the power on with the power circuit breaker switch in the off position.
Do not turn the power on with the power circuit breaker switch in the trip position.
(Contact your dealer.)

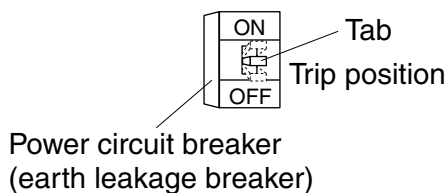

- Check if there is a power failure.
Wait until power is restored. If power failure occurs during operation, the system automatically restarts immediately after the power supply recovers.

2. If the system stops operating after operation is complete.

- Check if the air inlet or outlet of outdoor or indoor unit is blocked by obstacles.
Remove the obstacle and make it well-ventilated.
- Check if the air filter is clogged.
Ask a qualified service person to clean the air filters.
(Refer to "MAINTENANCE" on page 8.)
If the air filter is clogged, the airflow rate will drop and as a result the performance will also drop.
In addition, this may cause dew condensation at the air outlet.
(Refer to "MAINTENANCE" on page 8.)

3. The system operates but it does not sufficiently cool or heat.

- If the air inlet or outlet of the indoor or the outdoor unit is blocked with obstacles.

Note: After a while, the vertical airflow adjustment flaps at the air outlet are closed while the unit stops.

Remove the obstacle and make it well-ventilated.

Obstacles decrease the airflow rate, and cause performance decrease and breakage when discharged air is suctioned.

They cause a waste of electricity, and that may stop the devices.

- If the air filter is clogged.

Ask a qualified service person to clean the air filters.

(Refer to "MAINTENANCE" on page 8.)

A decrease in the airflow volume of the air conditioner will result and the performance of the air conditioner will be degraded if the air filter is clogged with dust or dirt.

In addition, this may cause dew condensation at the air outlet.

(Refer to "MAINTENANCE" on page 8.)

- If the set temperature is not proper (Set to an appropriate temperature, airflow rate, and discharge direction.).
- If the FAN SPEED button is set to LOW SPEED (Set to an appropriate temperature, airflow rate, and discharge direction.).
- If the airflow angle is not proper (Set to an appropriate temperature, airflow rate, and discharge direction.).
- If the doors or the windows are open. Shut doors or windows to prevent wind from coming in.
- If direct sunlight enters the room (when cooling). Use curtains or blinds.
- When there are too many inhabitants in the room (when cooling).
- If the heat source of the room is excessive (when cooling).

4. Though the on/off button was not pressed, the unit started or stopped.

- Are you sure that the ON/OFF timer operation is not used?
Turn off the ON/OFF timer.
- Are you sure that a remote control device is not connected?
Contact the central control room that directed the stop.
- Are you sure that the display for centralized control is not lit?
Contact the central control room that directed the stop.

If the problem is not solved after checking the above points, please do not try to repair it yourself. In such cases, always ask your local dealer. At this time, please tell the symptom and model name (written on the manufacturer's label).

If one of the following malfunctions occurs, take the measures shown below and contact your Daikin dealer.

The system must be repaired by a qualified service person.

⚠ WARNING

When the air conditioner is in abnormal conditions (smell of something burning, etc), unplug the power cord from the outlet

Continued operation under such circumstances may result in a failure, electric shock, and fire. Contact your dealer.

- If a safety device such as a fuse, a power circuit breaker or an earth leakage breaker frequently actuates;
Measure: Do not turn on the main power switch.
- If the ON/OFF switch does not properly work;
Measure: Turn off the main power switch
- If water leaks from unit.
Measure: Stop the operation.
- If the display “”, “UNIT No.”, and the OPERATION lamp flash and the “MALFUNCTION CODE” appears. (In case of BRC1D)

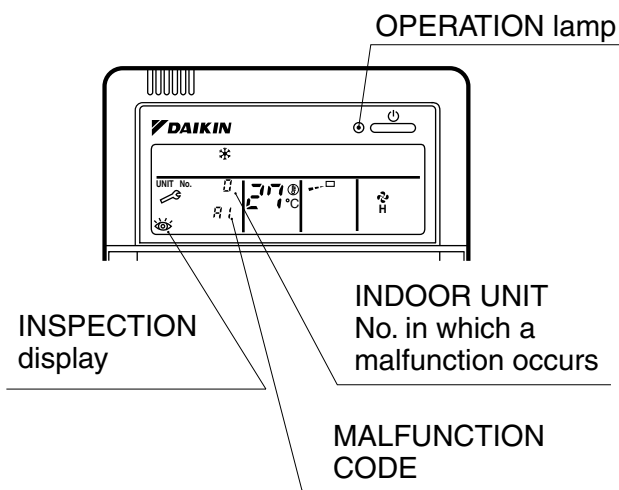

Measure: Notify your Daikin dealer and inform him/her of the display.

DAIKIN EUROPE N.V.

Zandvoordestraat 300, B-8400 Oostende, Belgium